

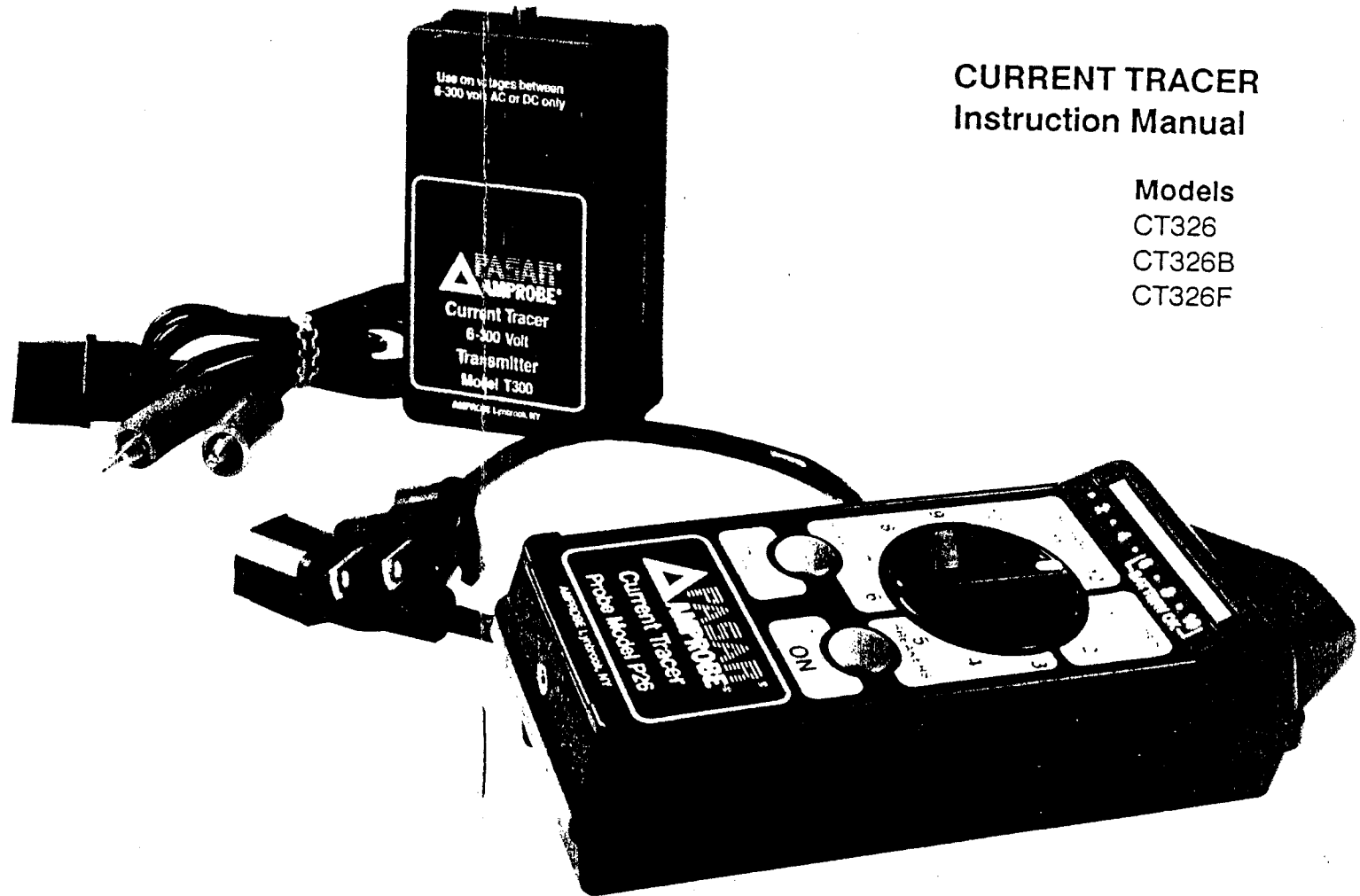

## CURRENT TRACER Instruction Manual

Models  
CT326  
CT326B  
CT326F



Made in USA Patented

**PRECAUTIONS  
FOR PERSONAL AND INSTRUMENT PROTECTION**

**IMPORTANT:**

1. Before using any electrical instrument, it should be checked to make certain it is operating properly.
2. In many instances, you will be working with dangerous levels of voltages and/or current, therefore, it is important that you avoid direct contact with any uninsulated, current-carrying surfaces. Appropriate insulated gloves, safety glasses and protective clothing should be worn.
3. If the instrument is accidentally connected to a voltage beyond the range of the instrument, immediately remove the instrument from the circuit.
4. When not in use, keep the instrument in its carrying case.
5. When the Probe will not be used for a period of time, remove the battery.

Copyright © 1988, 1990, 1991, 1995

 PASAR/AMPROBE

Subsidiary of Core Industries, Inc.

ALL RIGHTS RESERVED

## TABLE OF CONTENTS

---

### INTRODUCTION

---

#### Preface

Theory of Operation	1
---------------------	---

#### Components

T300 (6-300 Volt) Transmitter	2
Transmitter Signal	2
Transmitter Test Position	3
300-600 Volt Converter	4
P26 Probe	4
Probe Signal	5
Probe Sensitivity	6
Probe Test Position	8

---

### APPLICATIONS

---

#### Locating and Tracing

Circuit Breakers, Fuses	9
Neutral Lines within a Breaker Panel	11
Phases, Main Breakers, Transformers, Switch Gear	11
Wires in Floors, Walls, Ceilings	12
Individual Wires within Bundles	14
Conduit	14
Underground Wires, Buried Cables	16
Using an Independent Power Supply	18
Neutral Wires, Ground Wires	21
Open Breakers	22
Wire to Wire Shorts	23
Shorts to Ground	25

## TABLE OF CONTENTS (con't.)

---

### APPLICATIONS

---

#### Locating and Tracing (con't.)

Ground Faults - Ungrounded Systems	27
Control Circuits	29
Computer Coax Cables	30
Plumbing	31

---

### APPENDIX

---

#### Maintenance

Transmitter Fuse Replacement	32
Probe Battery Replacement	32
Trouble-shooting the Current Tracer	33

#### Warranty

34

#### Questions and Answers

35

#### Specifications

40

The Current Tracer can trace any energized circuit, its neutral or ground line from any location in a facility back through main distribution panels, through transformers and switch gear. Without interrupting power or disturbing sensitive electronic equipment, you can locate:

- |                          |                         |                       |
|--------------------------|-------------------------|-----------------------|
| <b>Circuit Breakers</b>  | <b>Control Circuits</b> | <b>Buried Cable</b>   |
| <b>Open Breakers</b>     | <b>Computer Cable</b>   | <b>Short Circuits</b> |
| <b>Hidden Wires</b>      | <b>Fuses</b>            | <b>Ground Faults</b>  |
| <b>Underground Wires</b> | <b>Conduit</b>          | <b>Plumbing</b>       |
| <b>Neutral Lines</b>     |                         |                       |

The AMPROBE PASAR® Current Tracer is a hand-held circuit tracing device for locating and tracing circuit breakers and "hot" and neutral conductors, (6-600 volts), without turning off power or interrupting sensitive electronic equipment.

The Current Tracer consists of a Transmitter and a Probe for tracing 6-300 volt circuits, AC or DC. A converter adapts the Transmitter for tracing 300-600 volt circuits, AC. The Transmitter, when connected to a power source, draws short bursts of high frequency current (1/4 amp peak load at 6.25 KHz) from the power line 71 times per minute. The Probe detects the resulting magnetic field surrounding the conductors that supply power to the Transmitter (see Fig. 1). With custom digital filtering, the Probe visually and audibly indicates which circuit is carrying the Transmitter's low ampere, high frequency load.

There are no distance limitations with the Current Tracer since it works by drawing a small load current from the power source, not by injecting an RF signal. Furthermore, this keeps the Current Tracer's signal confined to the circuit to which it is applied instead of "bleeding off" onto other circuits. Therefore, the signal will travel from the Transmitter to the source of power (the power generating station) and back on the neutral, totally unaffected by distance. It's quick, easy and safe to use!

Fig. 1

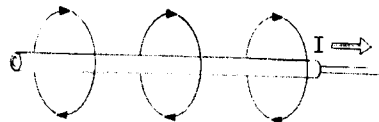

Magnetic Field

### T300 (6-300 Volt) Transmitter

The T300 Transmitter is designed for tracing 6-300 volt AC or DC circuits by drawing a high frequency load current from a power source, thus creating a traceable magnetic field around the conductors supplying its power (see Fig. 2). The Transmitter houses a crystal controlled digital circuit that never needs adjusting, and will not interfere with sensitive electronic equipment on the line.

### Transmitter Signal

When properly connected to the circuit to be traced, the red LED on the fuse end of the Transmitter blinks at a steady rate of 71 times per minute. This indicates that the Transmitter is operating, and that there is power on the line.

Fig. 2

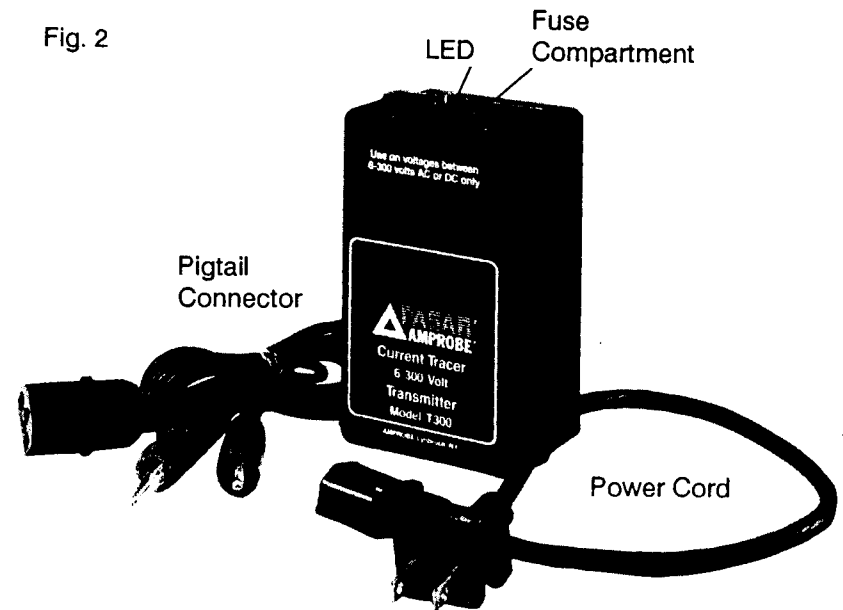

T300 Transmitter

*Transmitter Test Position*

1. Plug the Transmitter into any standard electrical outlet (see Fig. 3). If there is no outlet available, use the pigtail connector provided in the carrying case.
2. Verify that the Transmitter's red LED is blinking.
3. If the LED is not blinking, confirm whether or not the outlet is energized with a voltmeter. The Transmitter must be able to draw current in order to operate.
4. If the LED is not blinking and the outlet has been confirmed to be energized, remove the Transmitter from the outlet and check the fuse located on the LED end of the Transmitter. The Transmitter may have an open fuse if it has been attached to voltages higher than its range (see TRANSMITTER FUSE REPLACEMENT, p. 32).
5. Repeat steps 1 and 2.

Fig. 3

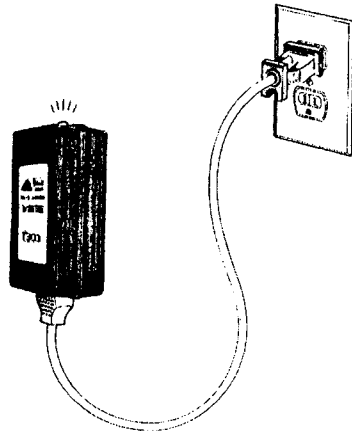
**Transmitter Test Position**

**IMPORTANT:** For locating and tracing applications, always use a voltmeter to determine the line voltage before connecting the Transmitter.

*300-600 Volt Converter*

The T300 Transmitter must be connected to voltages 6-300 volts AC or DC **only**. For applications of 300-600 volts AC, use the AMPROBE PASAR 600CKA Wide Range Converter with the T300 Transmitter (see Fig. 4). The Wide Range Converter is a hybrid transformer system which is specially designed to eliminate reduction of the Transmitter's signal while operating at high voltages. It is equipped with a receptacle for plugging in the T300 Transmitter and two insulated clips for attaching to conductors. A non-replaceable, internal fuse will open if the converter is attached to voltages out of its upper range.

Fig. 4

**600CKA Converter***P26 Probe*

The P26 Probe is a tuned, magnetic field strength meter (see Fig. 5, p. 5). When waved over conductors or circuit breakers, the sensor in the Probe's tip ignores other line current fluctuations and identifies the conductors feeding power to the Transmitter.

### Probe Signal

The Probe provides both an audio and visual indication when it is within range of the wires or circuit breakers supplying power to the Transmitter. The audio indication is a 3.125KHz tone. The visual indication is provided by a 10 position LED display. An earphone is included for use with the Probe when background noise makes the audio indication difficult to hear.

Fig. 5

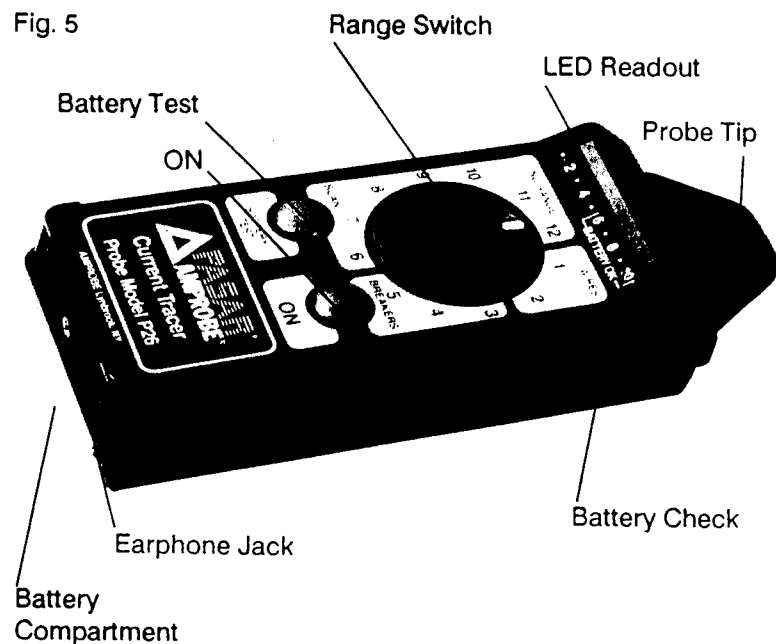

P26 Probe

### Probe Sensitivity

The Probe's range switch determines the Probe's gain. Probe sensitivity depends on three things:

1. **Angle of the Probe:** The Probe's tip must be held perpendicular to the conductor in order to allow the conductor's magnetic field and the Probe's sensor to couple most effectively (see Fig. 6).
2. **Position of the Range Switch:** If the Probe displays 10 LEDs, the gain is too sensitive (except in the test position). Turn the range switch to a lower setting (see Figs. 7 and 8, p. 7).
3. **Battery:** Change the Probe's battery if the battery test does not cause the LEDs to light within the "Battery OK" area (see PROBE BATTERY REPLACEMENT, p. 32).

Fig. 6

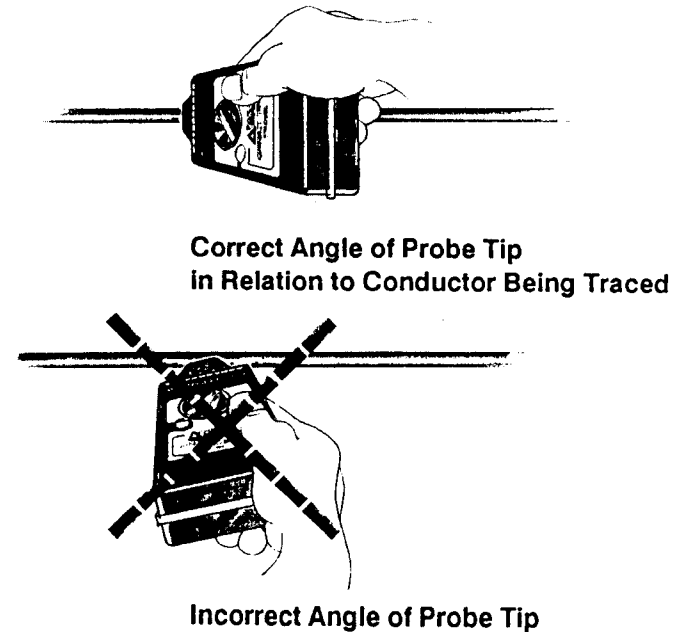

RANGE SWITCH	APPLICATIONS
WIRES (most selective)	Locate conductor in bundle Locate conductor entering a breaker switch
BREAKERS	Locate individual circuit breaker switches Test position
SCAN	Locate conductors in floors, walls, ceilings, and conduit Locate correct breaker panel
LONG RANGE (most sensitive)	Locate underground cable Locate wire to wire short

Fig. 7 Probe Range and Applications

**P26 PROBE GAIN**  
Using Looped Wire Test Setup

Range Setting	Distance from Wire for Half Scale Reading		Approximate Relative Gain
	in/ft	cm/m	
1 Wires	1.5 in	3.8 cm	X 1
2 Wires	2.5 in	6.4 cm	X 2
3 Breakers	4.0 in	10.2 cm	X 3
4 Breakers	6.0 in	15.2 cm	X 5
5 Breakers	10.0 in	26.7 cm	X 10
6 Scan	18.0 in	45.7 cm	X 25
7 Scan	2.5 ft	0.8 m	X 50
8 Scan	3.8 ft	1.1 m	X 90
9 Scan	6.0 ft	1.8 m	X 160
10 Scan	7.5 ft	2.3 m	X 240
11 Long Range	11.0 ft	3.3 m	X 450
12 Long Range	13.0 ft	3.9 m	X 850

Fig. 8 Sensitivity of Probe's Gain

*Probe Test Position*

1. To test the Probe's battery, press the "Battery Test" button. If the LED display does not light up within the "Battery OK" area, replace the battery and repeat (see PROBE BATTERY REPLACEMENT, p. 32).
2. Turn the Probe's range switch to "Breakers-5."
3. Press "ON" and wait 2 seconds for the Probe to calibrate. Holding the calibrated Probe, touch its tip to the front and center of the operating Transmitter (see Fig. 9). Ten LEDs will flash brightly, in sequence from left to right, at the same rate as the Transmitter's LED, indicating that the Probe is working correctly. This flashing LED response from the Probe is what you will be looking for as you trace circuits.

Fig. 9

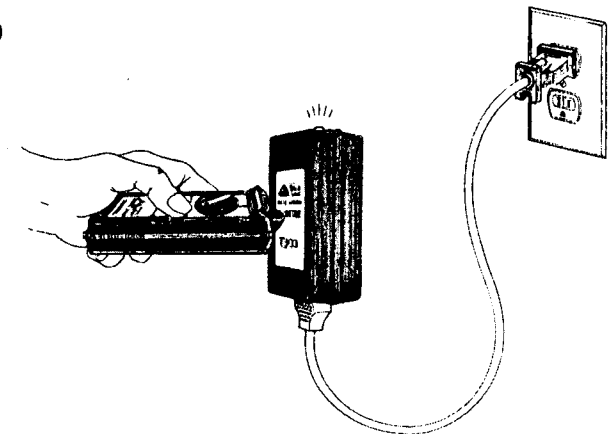

Probe Test Position

**Circuit Breakers, Fuses**

1. Plug the Transmitter into an outlet, or attach with the insulated clip leads of the pigtail connector to the conductors you want to identify.
2. Turn the Probe's range switch to "Scan-8."
3. Press the Probe's "ON" button and wait for it to calibrate.
4. Wave the Probe's tip slowly outside the closed panel box door and observe the Probe's signal. As the Probe approaches the correct panel box, the audio indication becomes louder and the LEDs will flash. Use the Probe's earphone, if necessary, to hear the signal.
5. The correct panel box produces the strongest signal. Not all LEDs need to flash in order to signal the correct panel. However, if the Probe's signal is of equal intensity on more than one panel, the gain may be set too high. Turn the range switch to a lower setting, i.e., "Breakers-5."
6. Open the panel box door.
7. Turn the Probe's range switch to "Breakers-4."
8. Press the Probe's "ON" button and wait for it to calibrate.
9. Touch the Probe's tip to each circuit breaker as shown in Fig. 10, p. 10. The Probe's tip must be held at the correct angle to the breaker to ensure accuracy. As the Probe approaches the correct breaker, the audio indication becomes louder and the LEDs will flash.
10. The breaker controlling the circuit being traced produces the strongest signal. Not all LEDs need to flash in order to signal the correct breaker. However, if the Probe's signal is of equal intensity on more than one breaker, the gain may be set too high. Turn the range switch to a lower setting, i.e., "Breakers-3" or "Wires-2." If positive identification is still not possible, proceed to steps 11 - 14 on page 10.

**Circuit Breakers, Fuses (con't.)**

11. Remove the panel trim.
12. Turn the Probe's range switch to "Wires-1."
13. Press the Probe's "ON" button and wait for it to calibrate.
14. Touch the Probe's tip on the wire connected to breaker previously identified. The Probe's tip must be held at the correct angle to the wire to ensure accuracy (see Figs. 6 and 10). Only the wires that the Transmitter is attached to will produce a signal.

Follow steps 1 - 10 on page 9 to locate fuses.

Fig. 10

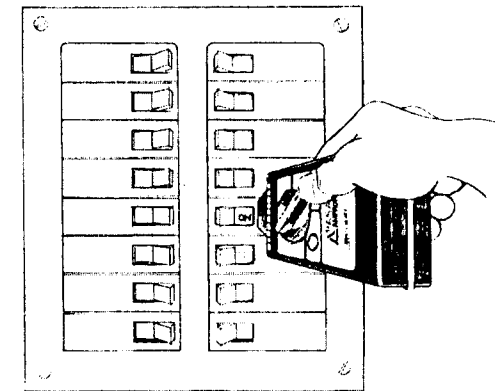

**Correct Angle of Probe Tip to Circuit Breaker for Most Accurate Reading**



### Neutral Lines within a Breaker Panel

Neutral lines may also be traced since the magnetic signal produced by the Transmitter returns on the circuit's neutral line.

Follow steps 1 - 14 on pages 9 and 10..

15. With the panel trim removed and the Probe's range switch set on "Wires-1," touch the Probe's tip to the neutral wires in the breaker panel. The Probe will indicate only on the neutral of the circuit to which the Transmitter is attached.

### Phases, Main Breakers, Transformers, Switch Gear

Since the Transmitter signal is current drawn from the power line, it will travel from the Transmitter to the source of power and back on the circuit's "hot" and neutral lines, totally unaffected by distance. Therefore, the Probe will be able to detect the phase that bears the circuit to which the Transmitter is attached, i.e. the remote main breaker, the utility box, the transformer, the switch gear, etc. These do not have to be in the same building or on the same floor as the location of the circuit where the Transmitter is attached.

As the Transmitter's signal passes through transformers, it is affected only by the step-up or step-down ratio of the transformer. For example, if the signal passes through a 2:1 step-down transformer, the signal will be reduced by one half, with the exception of the 600CKA Converter (see p. 4).

When tracing the path of the circuit through transformers, it may be necessary to set the Probe's range switch to a "Long Range" position (see Figs. 7 and 8).

### Wires in Floors, Walls, Ceilings

**IMPORTANT:** Since the load current on the conductors supplying power to the Transmitter flows in opposite directions on the "hot" and neutral wires, the magnetic field surrounding these conductors radiates in the opposite direction. (see Fig. 11). Therefore, when the "hot" and neutral wires are within close proximity, they tend to cancel the force of each other's magnetic field. For this reason, it is advisable to *separate the current paths* in order to trace them. The easiest and most effective way to do this is to use a separate ground, not adjacent to the ground of the circuit being traced, to provide a current path back to the power source.

Fig. 11

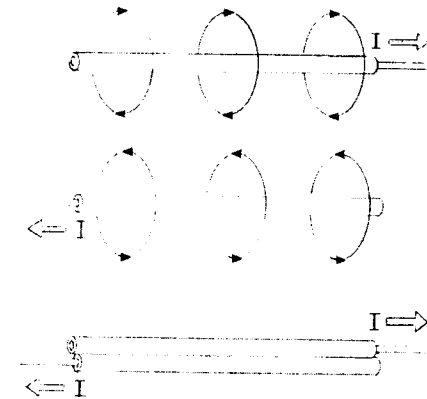

Direction of Load Current on Conductors

*Wires in Floors, Walls, Ceilings (con't.)*

1. Plug the pigtail connector into the Transmitter.
2. Attach one of the pigtail connector's insulated clip leads to a *separate ground*, such as a water pipe (see Fig. 12). As an alternative, use the neutral wire from another circuit away from the circuit being traced.
3. Attach the other lead to the "hot" conductor of the circuit you wish to trace. The Transmitter's LED will blink to indicate it is operating and that the circuit is complete.
4. Turn the Probe's range switch to "Scan-6."
5. Press the Probe's "ON" button and wait for it to calibrate.

Fig. 12

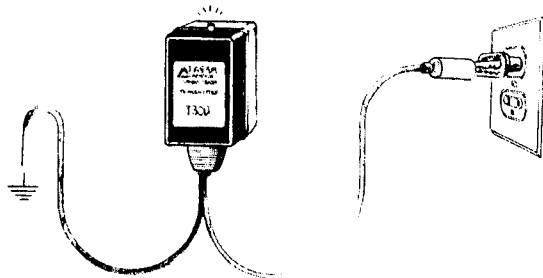

Separate Ground Connection

**NOTE:** Be sure to follow the "hot" conductor and not the ground path or neutral wire used to supply power to the Transmitter.

**CAUTION:** Do not connect the Transmitter to a separate ground in Electrically Susceptible Patient areas of a health care facility. Make the ground connection first and disconnect it last when using the pigtail connector.

*Wires in Floors, Walls, Ceilings (con't.)*

6. Hold the Probe's tip close to the floor, wall, or ceiling where you suspect the conductor is located.
7. Sweep the Probe across large areas until the Probe's signal locates the conductor. Narrow down the location of the conductor by changing the angle of the Probe and adjusting the range switch as necessary.

*Individual Wires within Bundles*

When tracing wires bundled together, it may be necessary to separate them to reduce magnetic coupling to nearby wires (see p. 12).

*Conduit*

1. Plug the pigtail connector into the Transmitter.
2. Attach one of the pigtail connector's insulated clip leads to a *separate ground* such as a water pipe. Be sure the ground path you choose is not adjacent to the conduit you wish to trace.
3. Attach the other lead to the "hot" conductor that runs inside the conduit you wish to trace. The Transmitter's LED will blink to indicate it is operating and that the circuit is complete.
4. Turn the Probe's range switch to "Scan-6." Since conduit will frequently cause the signal to become weaker, turn the Probe's range switch to a higher gain as necessary (see Figs. 7 and 8).

*Conduit (con't.)*

5. Press the Probe's "ON" button and wait for it to calibrate.
6. Hold the Probe's tip close to the location where you suspect the conduit runs.
7. Sweep the Probe across large areas until its signal locates the conduit. Narrow down the location of the conduit by adjusting the range switch (see Figs. 7 and 8) and changing the angle of the Probe (see Fig. 6).

Fig. 13

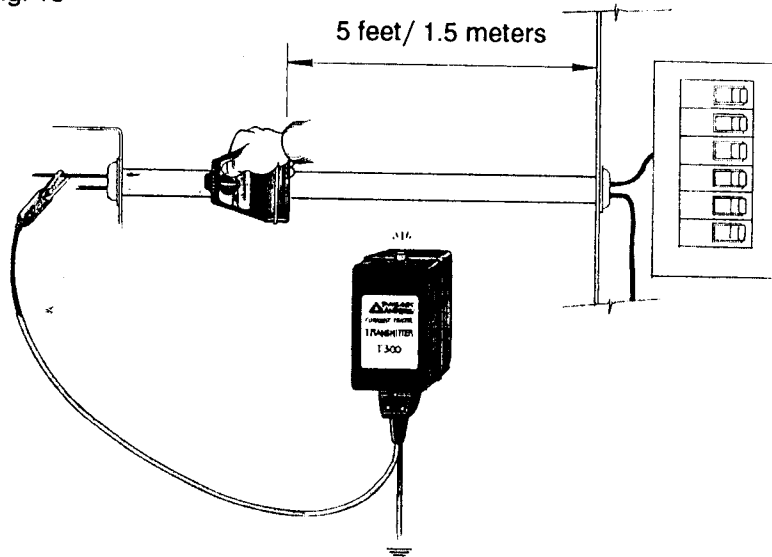

**Probe Distance from Circuit Breaker Panel  
when Tracing Conduit**

See CAUTIONS and NOTES on page 16.

*Conduit (con't.)*

Fig. 13 (con't.)

**NOTE:** Be sure you are following the "hot" conductor within the conduit and not the ground path or neutral wire used to complete the circuit. Do not use the conduit you wish to trace for the ground connection.

Since the feeder panel may radiate the magnetic field to the nearby conduit, make sure the Probe is always used more than 5 feet (1.5 meters) away from the circuit breaker panel during this application (see Fig. 13).

**CAUTION:** Make the ground connection first and disconnect it last when using the pigtail connector.

Do not connect the Transmitter to a separate ground in Electrically Susceptible Patient areas of a health care facility.

*Underground Wires, Buried Cables*

1. Plug the pigtail connector into the Transmitter.
2. Attach one of the pigtail connector's insulated clip leads to a *separate ground* such as a metal rod planted in the earth.
3. Attach the other lead to the "hot" conductor of the circuit you wish to trace. The Transmitter's LED will blink to indicate it is operating and that the circuit is complete.
4. Turn the Probe's range switch to "Scan-12."
5. Press the Probe's "ON" button and wait for it to calibrate.

*Underground Wires, Buried Cables (con't.)*

6. Hold the Probe over the surface and walk in the area where you suspect the conductor is located (see Figs. 14 and 14A). If this is unknown, walk in a large arc in the suspected area while keeping in mind the orientation of the Probe's tip to the conductor (see Fig. 6).
7. Once a signal has been detected, follow it until the maximum reading of LEDs is found. Narrow down the location of the conductor by changing the angle of the Probe and adjusting the range switch as necessary (see Figs. 7 & 8). Remember that the Probe's signal will vary as the conductor's depth varies. The conductor will be located where you have the strongest indication.
8. Repeat this procedure from the opposite end of the conductor to insure the correct location.

Fig. 14

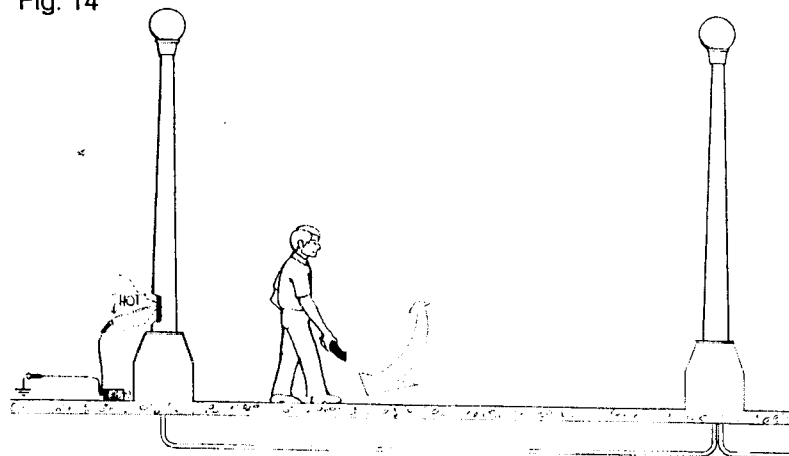

Tracing Underground Wires, Buried Cables

See CAUTIONS and NOTES on page 18.

Fig. 14 (con't.)

**NOTE:** Be sure you are following the cable you wish to trace and not the ground path used to complete the circuit.

**CAUTION:** Make the ground connection first and disconnect it last when using the pigtail connector.

### *Underground Wire, Buried Cables Using an Independent Power Supply*

#### **WARNING**

**\*\*To use this method the conductor must not be energized.\*\***

1. Plug the pigtail connector into the Transmitter.
2. Attach one of the pigtail connector's insulated clip leads to a *separate ground* such as a metal rod planted in the earth. If the OPTIONAL WIRE LOOP is used, a separate ground is not needed (see Fig. 14A, p. 19).
3. Attach the other lead to a power source, i.e. a battery pack.
4. Connect the power supply to the conductor you wish to trace.
5. Turn the Probe's range switch to "Wires-1."
6. Press the Probe's "ON" button and wait for it to calibrate.
7. Place the tip of the Probe to the grounded side of the Transmitter. The Probe should indicate a full scale reading of 10 LEDs. If the Probe does not indicate this, the voltage that is being applied will have to be increased or total resistance of the circuit will have to be reduced (see NOTE on p. 19 and Fig. 14B on p. 20).
8. Follow the procedure as described in steps 6-8 for locating UNDERGROUND WIRES, BURIED CABLES, p. 17.

Underground Wires, Buried Cables (con't.)

Fig. 14A

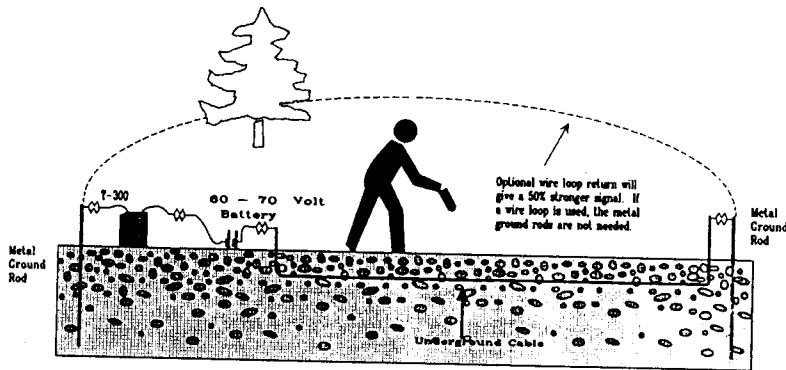

Locating Underground Conductors

**NOTE:** Soil has minimal effect on the magnetic field created by the T300 Transmitter. However, the signal will be reduced by as much as 50% when the return path is through ground due to the cancellation effect of the return signal. Typically, more voltage will be needed for dry soil and/or longer conductor lengths. The graphs on page 20 (Figs. 14B and 14C) show the voltage that must be applied to the Transmitter to overcome the effects of resistance and inductance of the circuit to develop an acceptable signal strength.

Fig. 14B

Transmitter Voltage Required to Overcome Return Path Resistance

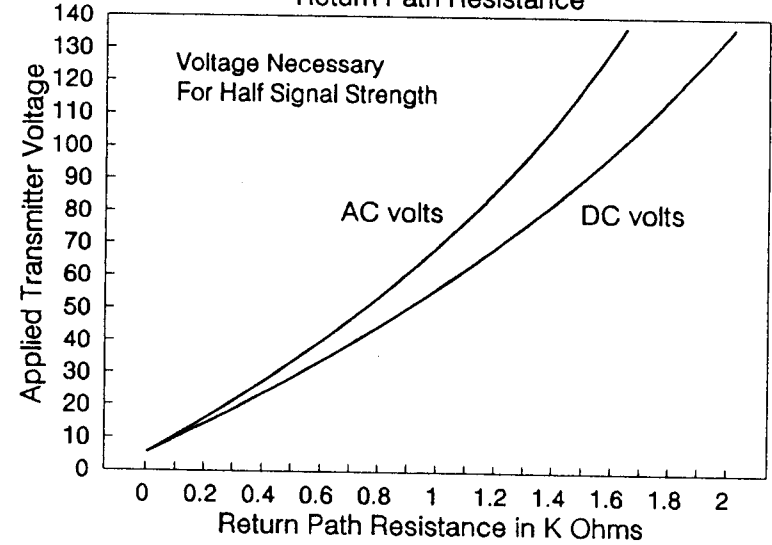
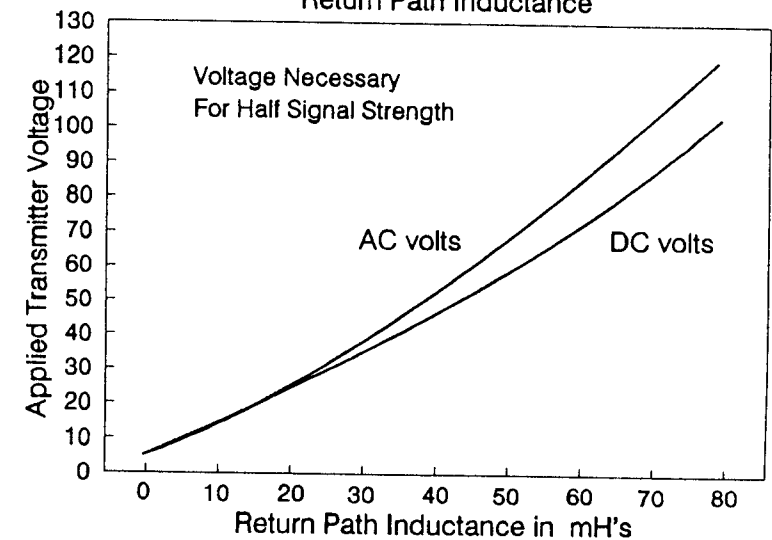

Fig. 14C

Transmitter Voltage Required to Overcome Return Path Inductance



**Neutral Wires, Ground Wires**

1. Plug the pigtail connector into the Transmitter.
2. Attach one of the pigtail connector's insulated clip leads to the circuit's neutral or ground.
3. Attach the other lead to a grounded 9 volt battery (see Fig. 15, p. 22). As an alternative, clip the other lead to the "hot" side of any grounded 6-300 volt power source. For example, an extension cord that is plugged into an energized outlet works well.
4. The Transmitter's LED will blink if the neutral wire is connected at the panel allowing the circuit to be traced.
5. Trace the neutral or ground wires with the Probe as explained in WIRES IN FLOORS, WALLS, CEILINGS, pgs. 12-14 and CONDUIT, pgs. 14-16.

**NOTE:** Be sure to follow the neutral or ground wire and not the "hot" conductor from the circuit used to supply power to the Transmitter.

**Open Breakers**

6. Attach the Transmitter and use the Probe to trace the neutral wire on the dead circuit as explained in steps 1-5.
7. When you can see the panel box, discontinue the above method and locate the correct circuit breaker panel and the neutral line within the panel as explained in CIRCUIT BREAKERS, FUSES, pgs. 9-10.
8. Visually locate the neutral's corresponding "hot" wire and circuit breaker. Use a voltmeter to verify the open breaker.

Fig. 15

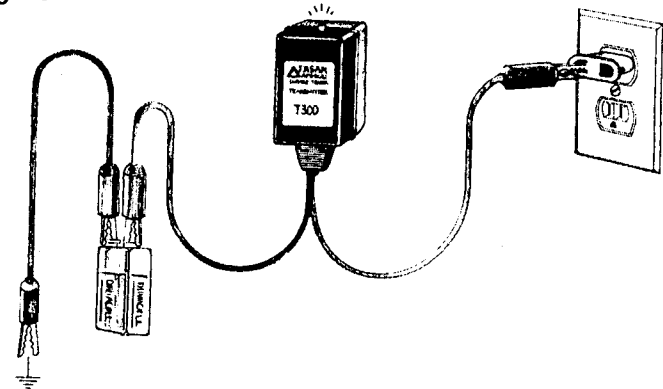
**Grounded 9 Volt Battery as Power Source**

**CAUTION:** Make the ground connection first and disconnect it last when using the pigtail connector.

Do not connect the Transmitter to a separate ground in Electrically Susceptible Patient areas of a health care facility.

**Wire to Wire Shorts**

1. Use an ohmmeter to locate the shorted pair of conductors.
2. Disconnect the conductors from power.
3. Plug the pigtail connector into the Transmitter.
4. Attach one of the pigtail connector's insulated clip leads to either of the shorted conductors.
5. Attach the other lead to either pole of a 9 volt battery (or other power source).
6. Connect the other pole of the battery to the other shorted conductor.
7. The Transmitter's LED will blink to indicate that it is operating and that current is flowing from the battery, through the Transmitter, and returning on the shorted conductors.
8. Turn the Probe's range switch to "Long Range-11."
9. Press the Probe's "ON" button and wait for it to calibrate.
10. Holding the Probe's tip as close to the shorted conductors as possible, move away from the Transmitter. Observe the Probe's LEDs for a dramatic change in signal strength. This will be the location of the short (see Fig. 16 on p. 24).

**Wire to Wire Shorts (con't.)**

Fig. 16

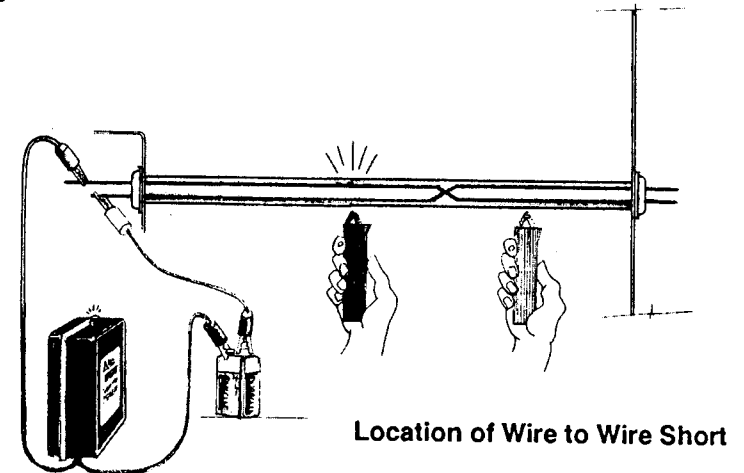

**CAUTION:** High voltage may exist, exercise extreme caution.

Make the ground connection first and disconnect it last when using the pigtail connector.

Remove the Transmitter from the circuit before clearing the short.

**NOTE:** For best results, it may be necessary to remove loads from the shorted circuit.

Since the Probe's signal should be fairly constant until the short is located, you may have to turn the range switch down to a more selective gain level in order to notice the dramatic change in signal strength.

### Shorts to Ground

1. Locate the tripped circuit breaker and make sure the switch is in the OFF position. You may be able to locate the tripped breaker by using the methods described in OPEN BREAKERS, p. 22).
2. Plug the pigtail connector into the Transmitter.
3. Attach one of the pigtail connector's insulated clip leads to the shorted power line.
4. Attach the other lead to the "hot" conductor of an adjacent breaker. As an alternative, attach this lead to a grounded 9 volt battery or other power source.
5. The Transmitter's LED will blink to indicate it is operating and that current is flowing from the adjacent breaker or power source through the Transmitter, using the shorted line as a neutral, and going to ground where the short occurs.
6. Turn the Probe's range switch to "Scan-6."
7. Press the Probe's "ON" button and wait for it to calibrate.
8. Holding the Probe's tip close to the shorted wire, move away from the Transmitter. Observe the Probe's LEDs for a dramatic change in signal strength. This is the location of the short (see Fig. 17, p. 26).

Fig. 17

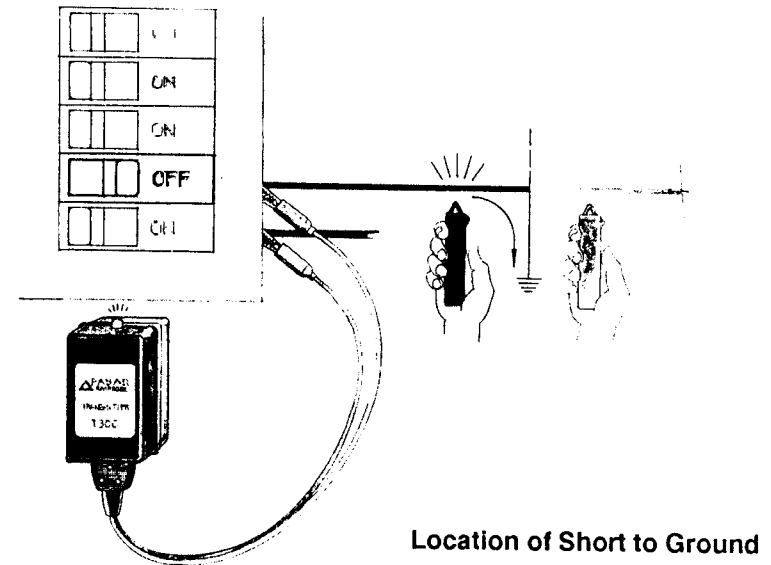
**Location of Short to Ground**

**NOTE:** For best results, it may be necessary to remove loads from the shorted circuit.

Since the Probe's signal should be fairly constant until the short is located, you may have to turn the range switch down to a more selective gain level in order to notice the dramatic change in signal strength.

**CAUTION:** High voltage may exist. Exercise extreme caution. Make the ground connection first and disconnect it last when using the pigtail connector. Remove the Transmitter from the circuit before clearing the short.



**Ground Faults - Ungrounded Systems****WARNING**

**\*\* DO NOT USE THIS TECHNIQUE ON INTERMITTENT GROUND FAULTS \*\***

1. Identify the faulty phase with a voltmeter. The grounded phase will have reduced voltage compared to the other phases.
2. Plug the pigtail connector into the Transmitter.
3. Attach one lead of the pigtail connector's insulated clip leads to a 6-300 volt AC/DC grounded power source (see Fig. 18).
4. Attach the pigtail connector's other clip lead to the power line with the ground fault.
5. The Transmitter's LED will blink if the ground fault impedance is low enough to allow the Transmitter to operate.
6. Turn the Probe's range switch to "Scan-6".
7. Press the Probe's "ON" button and wait for it to calibrate.
8. Hold the Probe's tip close to the conductor of the faulty phase and watch for a dramatic change in signal strength. This is the location of the fault (see Fig. 18, P. 28).

Fig. 18

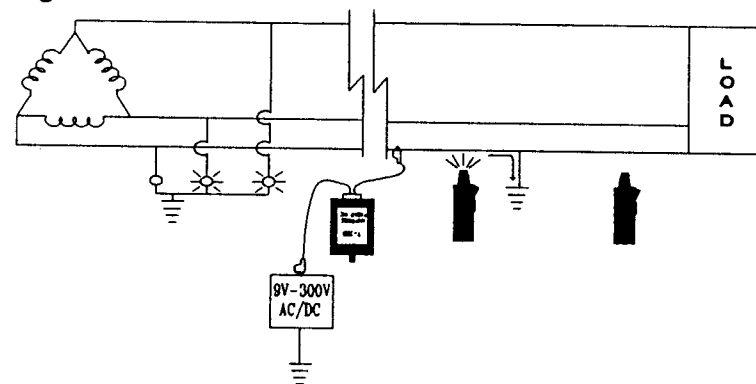
**Location of Ground Fault - Ungrounded System Only**

**NOTE:** For best results, it may be necessary to remove the fault indicator lamp on the faulty phase.

Since the Probe's signal should be fairly constant until the ground fault is located, you may have to turn the range switch down to a more selective gain level in order to notice the dramatic change in signal strength.

**CAUTION:** This method is not recommended for intermittent ground faults. High voltage may exist. Exercise extreme caution.

Make the ground connection first and disconnect it last when using the pigtail connector.

Remove the Transmitter from the circuit before clearing the ground fault.

*Control Circuits*

1. Plug the pigtail connector into the Transmitter.
2. Attach one of the pigtail connector's insulated clip leads to one side of the energized load in the circuit to be traced.
3. Attach the other lead to the other side of the load.
4. The Transmitter's LED will blink to indicate it is operating and that current is flowing in the circuit to be traced.
5. Turn the Probe's range switch to "Breakers-5."
6. Press the Probe's "ON" button and wait for it to calibrate.
7. Hold the Probe's tip close to the relay contacts, limit switches, etc., suspected to be in the circuit. The Probe's signal will indicate any conductor or device carrying the Transmitter's current (see Fig. 19).

Fig. 19

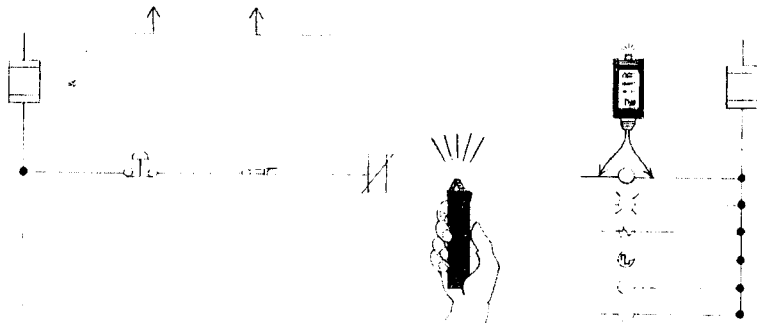
**Tracing Control Circuits***Computer Coax Cables*

1. Plug the pigtail connector into the Transmitter.
2. Attach one of the pigtail connector's insulated clip leads to the **shield** of the coax cable.
3. Attach the other lead to a grounded 9 volt battery.
4. The Transmitter's LED will blink to indicate that it is operating and that the circuit is complete (see Fig. 20). It is not necessary to disconnect the coax cable for this application. If the coax is connected, signal will travel toward ground in both directions and the strength will be reduced by one half.
5. Adjust the Probe's range switch as necessary, depending on access to the cable during the search (see Figs. 7 and 8).
6. Press the Probe's "ON" button and wait for it to calibrate.
7. Trace the coax cable with the Probe as explained in WIRES IN FLOORS, WALLS, CEILINGS (see pgs.12-14).

Fig. 20

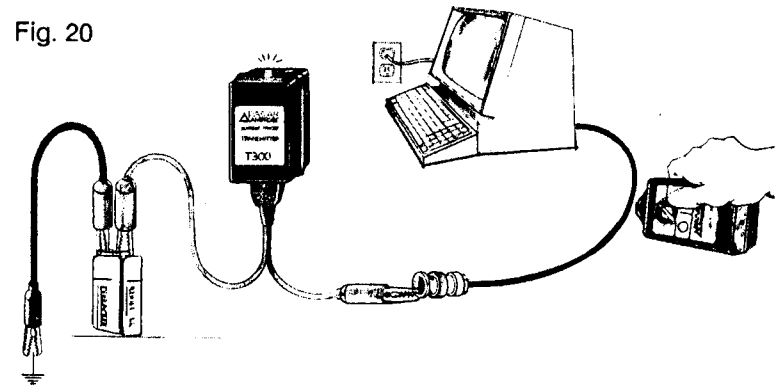
**Tracing Computer Coax Cable**

**NOTE:** Make sure the coax shield is grounded at the distant end. Check with the computer operator before disconnecting active computer cables.

### Plumbing

1. Attach a long wire to either pole of a 9 volt battery (or other power source) and the other end to the metal pipe to be traced.
2. Loop the wire away from the suspected path of the buried pipe.
3. Plug the pigtail connector into the Transmitter.
4. Attach one of the pigtail connector's insulated clip leads to the other end of the metal pipe.
5. Attach the other lead to the remaining pole of the battery.
6. Turn the Probe's range switch to "Scan-6".
7. Press the Probe's "ON" button and wait for it to calibrate.
8. Hold the Probe at a constant height from the surface and trace the pipe. Follow the path that gives the strongest signal (see Fig. 21).

Fig. 21

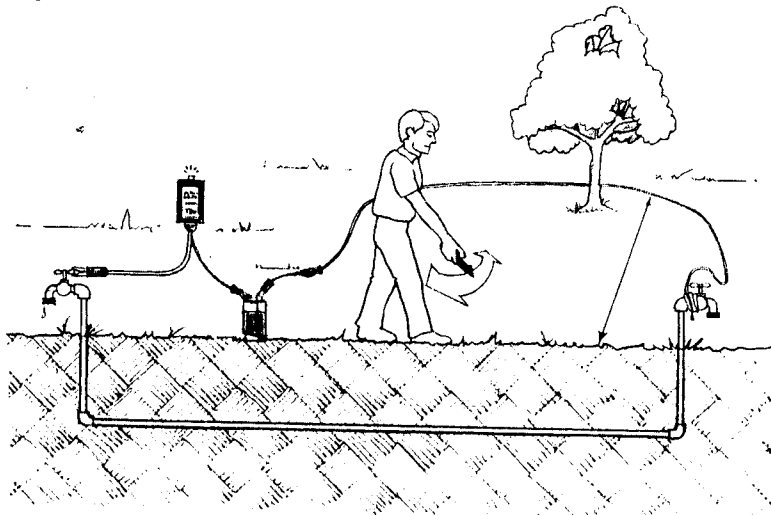

Tracing Plumbing

Neither the Probe or the Transmitter require user maintenance or calibration. Use alcohol and a soft cloth to clean the outside of the instruments if they become soiled.

### Transmitter Fuse Replacement

**Disconnect instrument from power before replacing the fuse.** Use a flat blade screwdriver to turn the fuse cap 1/4 turn counterclockwise. The fuse carrier and the fuse will pop out. Remove the fuse and replace it with the **same type of 1/4 amp, 250 volt normal blow fuse.** (An extra fuse has been provided in the carrying case.) Push the fuse and the fuse carrier back into the Transmitter using the screwdriver, and turn the cap clockwise until it locks.

### Probe Battery Replacement

The battery in the Probe should be tested before each use. To test the battery, press the "Battery Test" button. The LED readout should light up within the "Battery OK" section of the display. If it does not, replace the battery.

To replace the battery, hold the Probe face down and push the battery compartment door catch upward with your thumb; the battery cover should pop up exposing the battery. To remove the battery, strike the back of the Probe sharply in the palm of your hand. The replacement battery can then be inserted. Use a 9 volt **alkaline battery only.** **DO NOT FORCE THE BATTERY.** Observe the picture of the battery in the compartment as a guide to insert the battery correctly. Replace the battery door and be sure to perform the battery test procedure after the new battery is installed.

### *Troubleshooting the Current Tracer*

To test the operation of the Transmitter, connect it to a known power source from 6 to 300 volts AC or DC. The LED should begin to blink at a steady rate of approximately 71 times per minute. If it does not blink, check to ensure that there is proper voltage on the line and replace the fuse, if necessary (see TRANSMITTER FUSE REPLACEMENT, p. 32). If the LED still does not blink after checking the voltage and the fuse, send the Transmitter in for repair (see LIMITED WARRANTY, p. 34).

To test the operation of the Probe, attach a known good Transmitter to a 6-300 volt power source. Turn the Probe's range switch to "Breakers-5" and hold the tip to the front and center of the Transmitter. Press the "ON" button and wait 2 seconds for the Probe to calibrate. After calibration, 10 LEDs should flash from left to right in sync with the LED on the Transmitter. If it does not, the battery may be low (see PROBE BATTERY REPLACEMENT, p. 32). After replacing the battery and the LEDs still do not flash, send the Probe in for repair (see LIMITED WARRANTY, p. 34).

For additional information, see **APPENDIX Questions & Answers** or call **AMPROBE INSTRUMENT** at 1-800-477-VOLT for technical assistance.

### *Limited Warranty*

Your AMPROBE PASAR instrument has a limited warranty against defective materials and/or workmanship for two years from date of purchase, provided in the opinion of the factory, the instrument has not been tampered with or abused. Should your instrument fail due to defective materials and/or workmanship during the two year period, return it along with a copy of your dated bill of sale which must identify your instrument by model number and serial number.

**Above limited warranty covers repair and replacement of the instrument only and no other obligation is stated or implied. AMPROBE PASAR shall not be liable for any loss or damage arising out of the use or misuse of this product.**

For your protection, please use this instrument as soon as possible. If the unit is damaged or is ever in need of repair, please call AMPROBE at (516)593-5600 to obtain a Return of Materials Authorization (RMA) number. The unit should then be securely wrapped to prevent further damage in transit, insured and sent along with a proof of date purchased to:

Service Division  
AMPROBE INSTRUMENT  
630 Merrick Road (For U.P.S.)  
P.O. Box 329 (For P.P.)  
Lynbrook, N.Y. 11563-0329

Outside of the U.S.A., your AMPROBE PASAR representative will assist you.

1. **What type of power does the Transmitter require to operate?**  
*The Transmitter will operate from 6 to 300 volts at line frequencies from 0 to 1KHz.*
2. **Does that mean I can use a 9 volt battery as a power source?**  
*In most cases, yes. If one 9 volt battery isn't enough power, try hooking two or more together in series.*
3. **What happens if I connect the Transmitter to the wrong voltage?**  
*A 1/4 amp, 250 volt fuse will protect the Transmitter from damage.*
4. **Why not put a battery in the Transmitter so that it could be used without power on the line?**  
*If the Transmitter were battery operated, it would be injecting a signal onto the line instead of drawing the signal from the line. An injected signal travels throughout the system making it difficult to locate a particular circuit breaker or line.*
5. **How far will the signal travel?**  
*The Transmitter signal is current drawn from the power line. Therefore, it will travel from the Transmitter to the source of power and back on the neutral, unaffected by distance.*
6. **How deep of a buried cable can I locate?**  
*The Probe can locate and trace cables buried up to 13 feet or 4 meters underground.*
7. **What about neutral lines?**  
*Neutral lines may also be traced since the magnetic signal produced by the Transmitter returns on the circuit's neutral line.*

8. **Is the Transmitter signal affected by transformers?**  
*The Transmitter signal is affected by the step-up or step-down ratio of the transformer. For example, if the signal passes through a 2 to 1 step-down transformer, the signal will be reduced by one half.*
9. **Will the Transmitter signal effect any sensitive electronic equipment?**  
*No. This signal is only one quarter amp peak and produces less noise than a home dimmer switch. Only the Current Tracer Probe can detect this signal.*
10. **How can I trace power lines with voltages above 300 volts?**  
*The 300 to 600 Volt Converter can be used with the Transmitter. This should provide the Transmitter with voltage in its operating range. Always check the voltage with a voltmeter first to be sure.*
11. **Why do I have to make a separate connection to the Transmitter when tracing conductors through floors, walls, or conduit?**  
*The Transmitter causes current to flow in the "hot" conductor and the neutral or ground conductor. These two currents are alike but flow in opposite directions, and therefore they create opposing magnetic fields. When the two conductors are within close proximity, their magnetic fields tend to cancel each other. This reduces the field strength and decreases the Probe's ability to detect either conductor.*

12. **What are some examples of a "separate ground"?**  
*A separate ground can be any non-adjacent electrically conductive pathway to earth ground. This may include: cold water pipes, steel beams, metal door frames, grid ceilings, and HVAC duct work.*
13. **Will the Current Tracer trip a ground fault detector?**  
*Yes. Ground fault detectors will trip when the Transmitter is connected to ground.*
14. **Can the Current Tracer be used in Electrically Susceptible Patient areas?**  
*No. Do not use a separate ground with the Current Tracer when working in patient areas. A shock hazard to the patient could result from ground currents created by the Transmitter.*
15. **Can the Current Tracer be used in potentially explosive environment?**  
*No. Sparks may be generated when connections from the Transmitter to the line are made or broken.*
16. **What if I get the same reading on two different breakers?**  
*Try reducing the gain on the Probe until one breaker clearly has a stronger signal. If this does not give satisfactory results, remove the panel cover and check each wire coming into the breakers.*

17. **Is the Probe sensitive to noise?**  
*Noise on the power lines will have little effect on the Current Tracer. However, under extreme conditions noise may cause the Probe's LEDs to flash. This will not interfere with use of the Probe, however, because the Transmitter's signal will continue to pulse at its normal rate while noise will remain at a constant level or flicker without a pulse. It may be necessary to turn off the equipment causing the noise, if possible.*
18. **Can I connect the Transmitter at the fuse or breaker panel and identify the receptacle for that circuit?**  
*No. The Transmitter draws current from the source of power. The signal will only exist on the conductors from the Transmitter to the source.*
19. **What is the maximum distance from a conductor that the Probe can detect a signal?**  
*In the most sensitive position ("Long Range-12") it is possible to get a half scale reading 13 feet (4 meters) from the conductor. An audio indication will begin prior to the illumination of LEDs.*
20. **How long will the 9 volt battery in the Probe last?**  
*Depending upon its usage, the battery can last up to 100 hours. It is important to check the battery before each use by pressing the "Battery Test" button.*
21. **Can the Current Tracer be used on systems that have an Uninterruptable Power Supply (UPS)?**  
*Yes and no. The Current Tracer can be used above and below the UPS but not through it, because the UPS will filter out the Current Tracer's signal.*

**22. What is the life expectancy of the unit?**

*The Current Tracer is made with only high quality components. This unit should last well over ten years with normal use.*

**23. What makes the Current Tracer a quality product?**

*Digital design*

*Crystal controlled Transmitter*

*Special proprietary digital circuitry*

*Advanced signal filtering circuits*

*High noise rejection*

*Top quality components (Switches, ICs, LEDs, etc.)*

*Trim, durable design with laminated plastic label*

*Transmitter circuit thermal fuse protected*

*Probe incorporates 3 levels of insulation to protect the user*

*Manufactured in the USA*

**GENERAL**

Operating Frequency	6.25KHz
Operating Temperature	0°F to +120°F (-18°C to +49°C)
Storage Temperature	-40°F to +150°F (-40°C to +66°C)

**T300 TRANSMITTER**

Fuse	1/4 amp, 250V, Fast Acting Type U.S.A.: 1/4 x 1 1/4 FOREIGN: 5mm x 20mm
Case	Flame Resistant ABS Plastic
Operating Voltage	6 to 300 Volts AC or DC
Operating Frequency	6.25KHz
Line Frequency Range	DC to 1KHz
Maximum Load	200ma Peak at 110 Volts
Duty Cycle	Will transmit for .164 Second every .82 of a Second Crystal Controlled Digital Circuit

**P26 PROBE**

Power	9 Volt Alkaline Battery IEC #6LR61
Battery Life	100 Hours (with normal use)
Case	Flame Resistant ABS Plastic
50/60Hz Rejection	-156dB to 20K amps @ 50/60Hz

ACCESSORIES AND REPLACEMENTS

DESCRIPTION		AMPROBE ORDER NO.
Converter, Voltage (2:1)		600CKA
Pigtail Connector		PT26
Power cord (T300)	<i>U.S.A.:</i>	PC-326
	<i>FOREIGN:</i>	FC-326
Adapter		AD-1
Earphone, 3.5mm		EP1001
Fuse, 1/4 amp, 250V, Normal blow (T300)	<i>U.S.A.:</i>	3AG-312.250
	<i>FOREIGN:</i>	5X20-216.250
Battery, 9V alkaline		MN1604
Carrying Case		CC-326